

1 Cyclic shear tests on RC precast beam-to-column connections retrofitted with a 2 three-hinged steel device

3 Gennaro Magliulo Maddalena Cimmino Marianna Ercolino Gaetano Manfredi

4 G. Magliulo (corresponding author) – M. Cimmino – M. Ercolino – G. Manfredi
5 Department of Structures for Engineering and Architecture, University of Naples Federico II
6 Via Claudio 21, 80125 Naples, Italy
7 email: gmagliul@unina.it

8 **Abstract** Recent European earthquakes demonstrated that the seismic response of RC precast
9 structures can be significantly influenced by the connection systems. Moreover, during past seismic
10 events, many failures of the beam-to-column connections occurred due to their inadequate strength
11 under seismic loads. The seismic safety of these connections has a crucial role in the overall seismic
12 capacity of existing precast structures.

13 A new connection system is employed as a retrofitting solution for a damaged beam-to-column
14 connection and its cyclic shear performance is investigated by means of two cyclic shear tests on
15 two different configurations. In both the experimental tests, the results demonstrate an efficient
16 behavior of the retrofitted connections under horizontal cyclic loads. The comparison between the
17 performance of the investigated connection and the response of a typical beam-to-column dowel
18 connection allows to discuss the main critical features of the dowel connection system.

19
20 **Keywords** RC precast buildings; beam-to-column connections; cyclic shear tests; seismic
21 retrofitting; three-hinged steel system.

22 1 Introduction

23 In the last decades, RC precast structures were extensively used in all Europe as industrial
24 buildings. However, both the poor knowledge of their seismic behavior and the lack of specific
25 code provisions led to a high seismic vulnerability of the existing precast estate. During recent
26 seismic events, indeed, significant and extensive damages were exhibited by precast structures.
27 These seismic events also demonstrated that the structural safety of precast structures is an
28 important issue for both the human safety and the social/economic management of whole
29 regions/countries. The damage in a precast structure due to an earthquake can cause significant
30 losses: direct losses in terms of casualties, injuries, and repair/replacement costs as well as indirect
31 losses due to the interruption of the productive activities.

32 During some recent earthquakes, like L'Aquila (Italy) 2009 (Faggiano et al. 2009; Toniolo and
33 Colombo 2012), Van (Turkey) 2011 (Ozden et al. 2014), Christchurch (New Zealand) 2011 (Baird
34 et al. 2011) and Emilia (Italy) 2012 (Belleri et al. 2015a; Bournas et al. 2013; Magliulo et al.
35 2014b), the inadequate seismic response of these structures was mostly caused by the failure of the
36 connection systems between structural elements and structural and nonstructural components.
37 Indeed, even if an acceptable seismic safety is proved for precast structures when they are provided
38 with well-designed dowel connections (Kramar et al. 2010), in many structures the connections
39 were not designed for any seismic action and their premature failure during the seismic excitation
40 caused catastrophic collapses and structural damages. For instance, during the Emilia earthquakes
41 (2012), most of the failures were caused either by the absence of mechanical connections for the
42 structural elements (Magliulo et al. 2014b) or by the inadequacy of the connections between the
43 structure and the nonstructural components (Biondini et al. 2013), i.e. the cladding panels.

1 Several experimental and numerical research studies on precast structures were developed in the
2 last decade in order to: improve modern seismic codes for the design of new structures (Fischinger
3 et al. 2008; Toniolo 2012), assess the seismic safety of existing structures (Belleri et al. 2015a;
4 Bournas et al. 2013; Casotto et al. 2015) and define new retrofitting solutions (Belleri et al. 2015b;
5 da Fonseca et al. 2011). With regards to existing buildings, Magliulo et al. (2008) performed several
6 nonlinear analyses on existing precast structures in order to assess their seismic response. The
7 analyses results demonstrated that the strength of the frictional beam-to-column connections could
8 be lower than the seismic demand in low-medium seismic zones in Italy: in these areas the collapse
9 of the structures could occur due to the loss of the support in the beam-to-column connections.
10 Moreover, in the following years the same authors experimentally defined the frictional strength for
11 the typical existing frictional connections (neoprene-concrete) (Magliulo et al. 2011) and they found
12 out that the frictional coefficient values were lower than the values adopted in the previous study,
13 giving an even lower structural safety.

14 Belleri et al. (2015a) also performed an assessment study of existing precast buildings. By detailed
15 field observations of existing buildings in Emilia-Romagna region after the earthquakes, it was
16 found that the connection systems were the crucial elements in the structural seismic response. In
17 the study, the seismic performance of seven benchmark industrial structures with different
18 construction ages were described in details. Some numerical considerations were also performed in
19 order to justify the recorded loss of support phenomena under the recorded seismic loads in Emilia-
20 Romagna region.

21 Since the knowledge about the seismic retrofitting of RC precast structures is still poor if compared
22 to the cast in-situ RC structures, both the scientific and the technical community are addressing
23 growing efforts to the development of this topic. After the Emilia earthquakes, the Italian
24 government regulated the retrofitting actions for the structures in the epicentral area by issuing a
25 specific law (Legge 01/08/2012 n. 122 2012). Moreover, in order to give more detailed technical
26 indications, the “Guidelines on local and global retrofitting systems of precast structures” (Gruppo
27 di Lavoro Agibilità Sismica dei Capannoni Industriali 2012) were edited under the supervision of
28 the Italian Department of Civil Protection. According to the reference law, the seismic safety can be
29 obtained by means of a procedure consisting of two phases: a) the removal of the main structural
30 deficiencies; b) extensive and systematic actions in order to achieve the required seismic
31 performance, according to the current Italian code (D. M. 14/01/2008 2008). The first phase is
32 crucial and it requires quick emergency actions in order to obtain the positive usability judgment by
33 removing the main deficiencies, as the lack of connections between structural elements and the
34 inadequacy of connections between structural and nonstructural components. Some authors studied
35 innovative retrofitting solutions for existing precast buildings; however, few efficient solutions were
36 defined in the last years, such as mechanical devices for connections (Belleri et al. 2014; Belleri et
37 al. 2015b), dissipative systems (Biondini et al. 2013) and retrofitting techniques for vertical
38 elements (columns) and foundations (Belleri and Riva 2012; Belleri et al. 2015b), typically used for
39 RC frame structures.

40 Concerning the external cladding panels, the European SAFECLADDING project has been
41 developed in order to both assess the safety of the existing connections and define innovative
42 connection systems. (Biondini et al. 2013).

43 In this paper, a new retrofitting system is presented for precast connections. It consists of a three-
44 hinged steel device and it can be adopted for multiple structural elements and configurations. The
45 shear strength of the system is investigated by means of two cyclic tests on a damaged dowel beam-
46 to-column connection. Two different configurations were tested. The experimental results
47 demonstrate the efficient cyclic performance of the new connection system under shear loads;
48 moreover, the comparison with the cyclic behavior of the standard dowel connection shows the
49 more efficient performance of the three-hinged steel device in terms of both shear strength and
50 energy dissipation.

2 Tested specimen: retrofitted dowel beam-to-column connection

The reference connection is a dowel beam-to-column connection, typically used in RC precast structures (Dal Lago et al. 2016; Kremmyda et al. 2014; Psycharis and Mouzakis 2012; Zoubek et al. 2015). This connection was tested under cyclic shear loads up to collapse before installing the retrofitting system.

The specimen consists of a horizontal beam, connected to the North column (left side in Fig. 1a) by a dowel connection and simply supported on the South column (right side in Fig. 1a). The concrete elements were designed according to European provisions (CEN 2004; CEN 2005b): the reinforcement details for both the column and the beam are reported in Fig. 1b and Fig. 1c, respectively. The concrete characteristic cubic compressive strength was equal to 37N/mm^2 , whereas the reinforcement characteristic yielding strength was equal to 450N/mm^2 . In order to avoid large local stresses at the column-to-beam contact, a neoprene pad ($15\text{cm}\times 60\text{cm}\times 1\text{cm}$) was placed on the dowels side (left side in Fig. 1a), designed according to CNR provisions (CNR 10018 1999). On the South side of the specimen (right side in Fig. 1a) two teflon sheets avoided additional frictional strength at the beam-to-column surface.

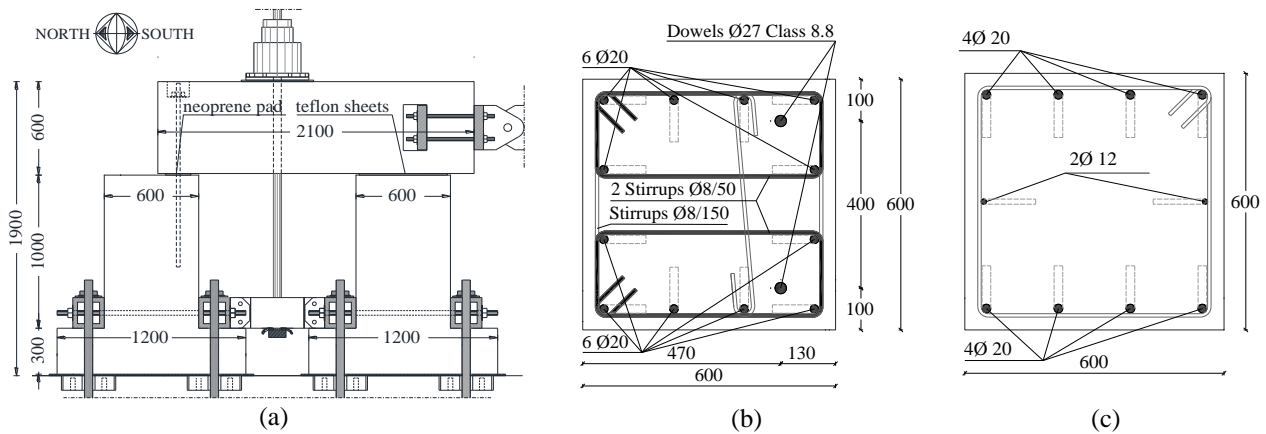

16 **Fig. 1** Setup of the cyclic shear test on the dowel connection: (a) specimen dimensions (in mm), (b) column and (c)
17 beam cross section details

18 The specimen was tested under vertical and cyclic horizontal loads. The vertical load was provided
19 by a vertical jack with a rate of 3kN/s up to the maximum value of 450kN , as recorded by a specific
20 load cell. The vertical load remained constant during the application of the cyclic horizontal load
21 and it was evaluated according to the seismic combination of actions in CEN (1990), by considering
22 dead and live loads in the seismic design situation for an internal beam of a typical geometrical
23 configuration of an industrial one-story building ($w=5\text{kN/m}^2$; tributary area equal to 90m^2). The
24 vertical jack was restrained to a pre-stressed metallic bar that crosses the precast beam through a
25 hole; a sleigh anchorage system was placed at the other side of the metallic pre-stressed bar, in
26 order to avoid undesirable restraining effects (Fig. 1).

27 The horizontal load was applied along the beam longitudinal axis by means of a hydraulic actuator,
28 controlling the displacements. Fig. 2 shows the protocol displacements recorded by the actuator
29 load cell: in this figure, the negative values correspond to horizontal displacements from North to
30 South, i.e. pulling the dowels against the column frontal cover (from left to right in Fig. 1);
31 conversely, positive values correspond to the horizontal displacements in the opposite direction
32 (from right to left in Fig. 1). The adopted loading protocol consisted of 17 displacement steps and,
33 for each step, three complete cycles (negative and positive semi-cycles) were performed. From the
34 first to the 12th step, the load was applied with a rate of 0.02mm/s and from the 13th step to the test
35 end the load rate was equal to 0.04mm/s . Additional details are given in Magliulo et al. (2015).

36 The effective connection response is described in Fig. 3 up to loading step in which the 20% of
37 shear strength reduction was reached, i.e. the connection collapse. Fig. 3 shows the horizontal shear

1 force along with the beam-to-column relative displacement: the negative values of both forces and
 2 displacements correspond to pulling loads (i.e. displacements from North to South in Fig. 1a),
 3 whereas the positive values of both forces and displacements correspond to pushing loads (i.e.
 4 displacements from South to North in Fig. 1a).
 5 For pushing loads, the connection exhibits larger shear strength and a quite limited stiffness
 6 degradation with respect to the results under pulling loads. A significant strength degradation occurs
 7 pulling loads after the attainment of the peak shear strength (176.57kN). This peak value
 8 corresponds to the occurrence of the first crack in the column concrete cover (red marker in Fig. 3).
 9 The connection failure occurs for very low beam-to-column relative displacements (2mm), due to
 10 the high initial stiffness of the connection system.
 11 Several cracks occurred in the cover of the column, up to the broad spalling of the concrete at the
 12 end of the test. Fig. 4 shows the final configuration of the damage pattern on both the beam and the
 13 column. The connection failure was caused by two main reasons: 1) the small concrete cover of the
 14 steel dowels with respect to the dowel diameter (Vintzeleou and Tassios 1986; Zoubek et al. 2013)
 15 and; 2) the low concrete confinement due to the large depth of the first stirrup at the column top
 16 (Magliulo et al. 2014a).
 17 A more accurate description of both the reference dowel connection and the experimental results of
 18 the cyclic test is reported in Magliulo et al. (2015).

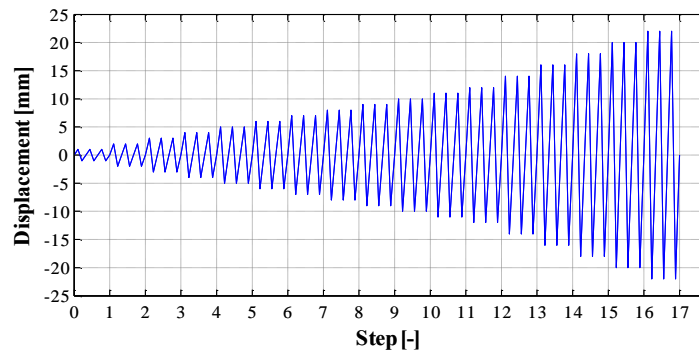

19
 20 **Fig. 2** Loading protocol of the cyclic shear test on the dowel beam-to-column connection

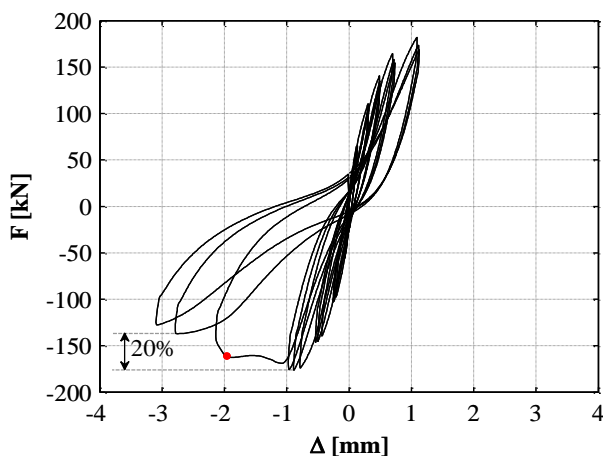

Fig. 3 Force-displacement curve for the dowel connection up to the 20% of the shear strength degradation

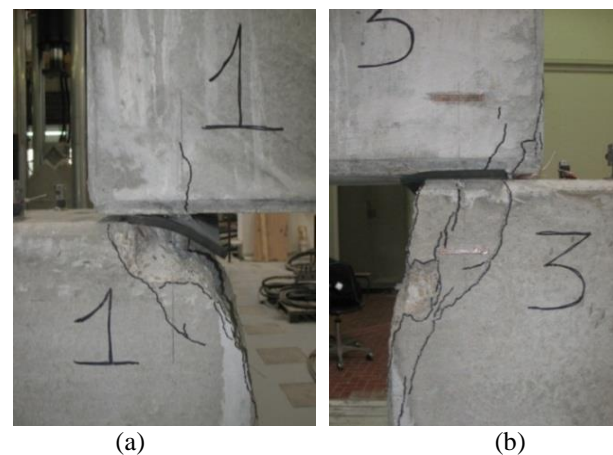

Fig. 4 Final damage pattern of the tested dowel connection: (a) West and (b) East view

21 After the cyclic shear test, the above described dowel connection was retrofitted by means of a
 22 three-hinged steel device. This system is a patented connection by Capozzi and Magliulo (2012),
 23 improved by Capozzi et al. (2014), which is applicable for both the retrofitting of existing structures
 24 and the new connections of structural and nonstructural elements.

1 In this study, the three-hinged steel connection was tested as retrofitting system of the above-
2 described beam-to-column connection when applied in one only direction, i.e. the direction of the
3 longitudinal axis of the beam, in order to absorb the corresponding shear forces. It consists of two
4 inclined steel plates anchored to the lateral surfaces of the connected concrete elements by means of
5 horizontal steel dowels. The steel dowels pass through the beam and the column by avoiding any
6 interference with the pre-existing reinforcement bars (Fig. 5). This system feature is generally due
7 to the limited cross-section dimensions of the connected elements, because the dowel length is
8 computed in order to prevent the failure of the concrete under tensile stresses according to ETAG
9 (1997). The steel elements are fixed together by nuts and washers, which ensure the possibility to
10 remove/reinstall the system after damage. The overall mass of the connection did not increase
11 because of the very low weight of the introduced retrofitting system with respect to the elements to
12 be connected. For shear forces in the transversal direction, an additional system can be orthogonally
13 arranged. However, the study of this coupled configuration is not the aim of the presented paper.
14 The proposed retrofitting solution is based on two main mechanical principles: the dowel action and
15 the three hinged arch. The former mechanism relies on the shear strength of the horizontal steel
16 dowels; the latter one is based on the axial forces in the two steel plates, so that the shear force
17 applied to the beam is transferred to a couple of hinges on the column. Considering different
18 installation arrangements, it is possible to guarantee a planar configuration of the steel plates so that
19 they carry neither flexural nor shear stresses and can be designed only for axial loads.
20 The design of the retrofitting system was performed according to Eurocodes provisions (CEN
21 2005a; CEN 2005b) and considering some specific rules for beam-to-column connections of precast
22 structures with cantilever columns in the Italian building code (D. M. 14/01/2008 2008).
23 The geometrical features of the retrofitting system are reported in Fig. 5. In the following, these
24 terms are adopted: i) the node on the beam is defined as “node 2”; ii) “node 1” and “node 3” are the
25 lower and the upper node on the column, respectively; iii) the steel plate from node 1 to node 2 is
26 referred to as “plate 1” and iv) the steel plate from node 2 to node 3 is the “plate 2”. An optimum
27 inclination of the steel plates was chosen in order to limit their axial force, avoiding their buckling
28 failure and the shear failure of the horizontal steel dowels.
29 The three dowels for the steel plates anchorage consist of threaded bars with a diameter of 30mm
30 and with a characteristic yielding strength of 640N/mm^2 (Class 8.8). The mechanical properties of
31 the steel dowels were verified by means of two tensile tests and they assume the following values:
32 effective cross section area $A_{\text{res}}=560\text{mm}^2$, nominal diameter $\phi_{\text{eq}}=26.7\text{mm}$, mean values of yielding
33 tensile strength $f_{\text{ym}}=685\text{N/mm}^2$, mean Young’s modulus $E_{\text{m}}=176660\text{N/mm}^2$ and mean axial strain at
34 yielding $\varepsilon_{\text{ym}}=0.003878$. The steel dowels were designed according to the provisions for pin
35 connections (CEN 2005a; CNR 10025/98 2000).
36 The design of the steel plates ($f_{\text{yk,plate}}=275\text{N/mm}^2$, $E_{\text{y,plate}}=210000\text{N/mm}^2$) was performed according
37 to the geometrical requirements of Eurocode 3 (CEN 2005a) for pin ended members and their
38 buckling failure was also prevented according to Eurocode 3 (CEN 2005a). Fig. 6 shows the
39 geometrical features of the two steel plates: Φ is the hole diameter and R is the radius of the plate
40 edges. The plate 1 has a greater thickness at the node 1 in order to allow a planar configuration.
41 The neoprene pad between beam and column was replaced after the cyclic test on the dowel
42 connection; it was designed according to the CNR provisions (CNR 10018 1999), resulting in the
43 same dimensions of the replaced pad (15cmx60cmx1cm).

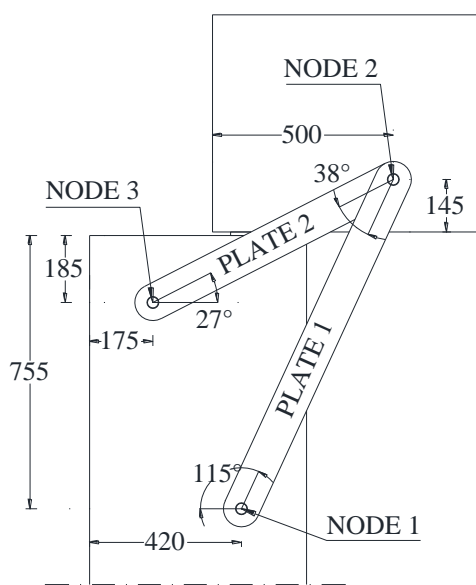

Fig. 5 Connection system configuration (dimensions are expressed in mm)

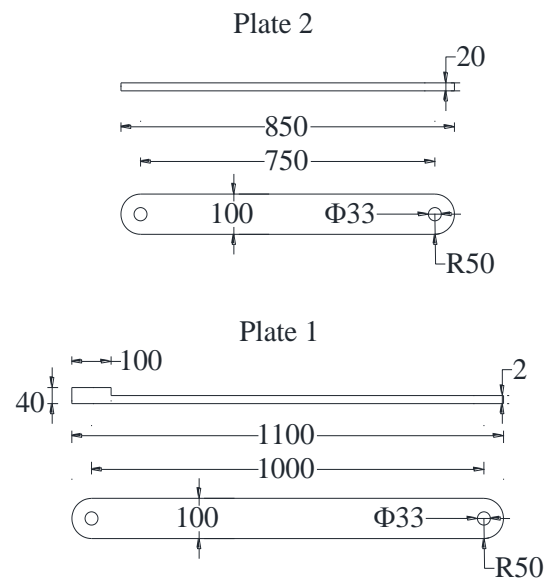

Fig. 6 Geometrical configuration of the steel plates (dimensions are expressed in mm)

1 The concrete elements were significantly damaged during the cyclic test on the dowel connection
 2 and they were repaired before the installation of the retrofitting system. At this aim, the original
 3 dowels were cut, the cracked concrete was completely removed and the concrete and steel surfaces
 4 were accurately cleaned. In order to reproduce the usual restoring procedure for damaged concrete
 5 elements, the beam and the column were repaired by means of a high strength and shrinkage
 6 compensated grout, with a characteristic compressive strength equal to 60N/mm^2 and to 75N/mm^2
 7 after 7 and 28 days, respectively. The grout was easily cast in situ because of its fluidity and good
 8 adhesive properties for both concrete and steel. The good mechanical properties of the cement
 9 based grout will influence the improvement of the connection behavior; however, further
 10 investigations should be performed to quantify their beneficial effects.

11 The installation steps of the retrofitting system are described in the following (Fig. 7).

12 a. The preliminary identification of the reinforcement in beam and column was performed
 13 through a magnetic rebar locator test, in order to choose the location of the holes without interfering
 14 with the existing steel elements (Fig. 7a).

15 b. The anchorage holes for the steel dowels were created in the concrete elements (Fig. 7b).

16 c. The system components, i.e. the dowels and the two plates, were installed (Fig. 7c). In the
 17 test 2 the rubber hose was also inserted in the holes.

18 d. The connection between the dowels and the concrete elements was provided by filling the
 19 holes with high strength grout. In order to guarantee the grout filling, the drilled hole diameter is
 20 2cm greater than the dowel diameter (Fig. 7d).

21 e. The connection was completed by tightening the nuts and the washers between the dowels
 22 and the plates. In this phase, a preliminary pre-stressing of the bars could be applied in order to
 23 guarantee a higher energy dissipation due to the friction. This pre-stressing forces were not
 24 provided in the described tests.

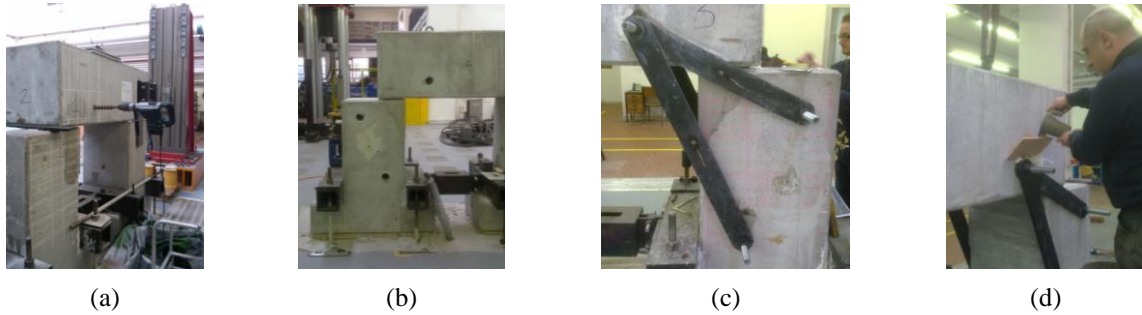

1 **Fig. 7** Installation phases: (a) reported location of the reinforcement bars; (b) anchorage holes; (c) installation of steel
 2 plates and dowels; (d) cast in situ of high strength grout

3 **3 Cyclic shear tests on the retrofitted connection**

4 *3.1 Loading protocol and instruments*

5 Two cyclic shear tests were performed on two beam-to-column connections.
 6 The first shear test (test 1) was performed on the retrofitted connection, previously tested under
 7 cyclic horizontal loads (Magliulo et al. 2015), without the rubber hoses around the horizontal
 8 dowels. The geometrical layout and the construction details of the connection system are described
 9 above (section 2). The second shear test (test 2) was performed on a retrofitted connection,
 10 previously tested under monotonic horizontal loads (Magliulo et al. 2014a). In this specimen the
 11 rubber hose was inserted around the horizontal steel dowel in the beam. This element was added to
 12 the system in order to improve the connection performance by reducing high local stresses in the
 13 concrete around the steel dowels, recorded in the test 1. Moreover, the rubber hose is applied to
 14 allow connection deformations for slow-rate loads, e.g. the thermal actions. According to these
 15 considerations, a 2mm rubber hose was adopted. The two retrofitted connections and the retrofitting
 16 systems have the same geometrical and mechanical features.
 17 The same vertical and horizontal loads were applied in both tests according to the loading protocols
 18 described in section 2. Since in retrofitted existing structures the gravity loads are applied to the
 19 structure before the installation of the retrofitting system, in the performed tests the vertical load
 20 was applied before tightening the connection device by means of nuts and washers.



Fig. 8 Setup of the cyclic test on the retrofitted
 beam-to-column connection

21 The cyclic shear response of the connections during the tests was recorded by means of several
 22 instruments, in order to describe its global and local behavior.
 23 In the following, the global behavior is described in terms of shear loads versus beam-to-column
 24 relative displacements as well as in terms of dissipated energy. The shear loads were recorded by a

1 load cell applied to the horizontal actuator and the horizontal displacements were recorded by two
2 LVDTs installed between the column top horizontal section and the beam end vertical surface, in
3 order to control both the beam-to-column relative displacements and the possible beam rotations
4 around the column vertical axis. The LVDT records confirm a pure translational behavior of the
5 connection. The dissipated energy was measured as the area under the hysteresis loops of the force-
6 relative displacement curves.
7 The local behavior is described in terms of damage pattern observed during the test as well as in
8 terms of local strains for steel and concrete members. The steel strains were recorded by means of
9 uniaxial strain gauges (length=6mm) installed along the longitudinal axis of the inclined steel
10 plates; the concrete strains were recorded on the concrete surfaces for beam and column, around the
11 horizontal steel dowels, by means of uniaxial strain gauges (length=60mm), placed orthogonally
12 with respect to the steel plates axes.
13 Finally, uniaxial strain gauges were placed on the horizontal steel dowels and they were embedded
14 in the concrete grout in order to record the axial strains (namely D1 at the node 1, D2 at the node 2
15 and D3 at the node 3).

16 3.2 Experimental results

17 In Fig. 9 the behavior of the retrofitted connection during the test 1 (without rubber hoses around
18 the horizontal dowel) is shown in terms of force-displacement curve, i.e. the shear forces and the
19 relative displacements between beam and column. The blue curve in Fig. 9 includes both the shear
20 strength of the retrofitting connection systems, placed on both the East and the West sides of the
21 tested specimen, and the concrete-to-neoprene friction forces, depending on both the contact surface
22 features and the acting vertical loads (Magliulo et al. 2011).

23 The negative values of forces and displacements correspond to pulling loads, i.e. horizontal loads
24 against the column frontal cover. The connection behavior is not symmetric in the two loading
25 directions because of an asymmetric distribution of the local stresses in the concrete. This evidence
26 can be justified by installation defects of the horizontal dowels and it is also demonstrated by the
27 different crack patterns in the two loading directions (Fig. 10). In the case of pushing loads (positive
28 values), a lower damage of the concrete corresponds to a higher initial stiffness with smaller relative
29 displacements than in the case of pulling loads. Concerning the pulling loads (negative values), the
30 force-displacement curve shows a clear pinching effect up to a relative horizontal displacement
31 equal to 7mm, due to the concrete damage around the horizontal dowels.

32 The diamond and circle markers in Fig. 9 correspond to the formation of the first crack in the node
33 2 on the beam concrete surface, along the steel plate 1 and 2, respectively. The cracks occurrence is
34 defined when the recorded axial strain ε on the beam surface (strain gauges B1-II and B2-II in Fig.
35 11) reached the axial strain value at the concrete tensile strength (f_{ctm}), i.e. $\varepsilon_t=0.01\%$ (Fig. 12). The
36 first crack along the plate 1 appeared during the first cycle of the 8th step, for a positive shear load
37 equal to 178.74kN, which corresponds to tensile axial forces for plate 1 and compressive axial
38 forces for plate 2. Instead, the first crack along the plate 2 appeared during the first cycle of the 11th
39 step, for a negative shear load equal to 149.42kN, which corresponds to tensile axial forces for plate
40 2 and compressive axial forces for plate 1.

41 It can be pointed out that, the concrete damage in the retrofitted connection occurred at a larger
42 beam-to-column relative displacements (i.e. 5mm) with respect to the dowel connection (i.e. 2mm,
43 see Fig. 3). Moreover, the retrofitted connection still exhibits a good performance after the concrete
44 damage, i.e. without an extreme strength degradation. Indeed, the maximum recorded shear force
45 reached the value of 293.58kN for positive loading semi-cycles (first cycle of the 14th step) and of
46 312.98kN for negative loading semi-cycles (first cycle of the 17th step).

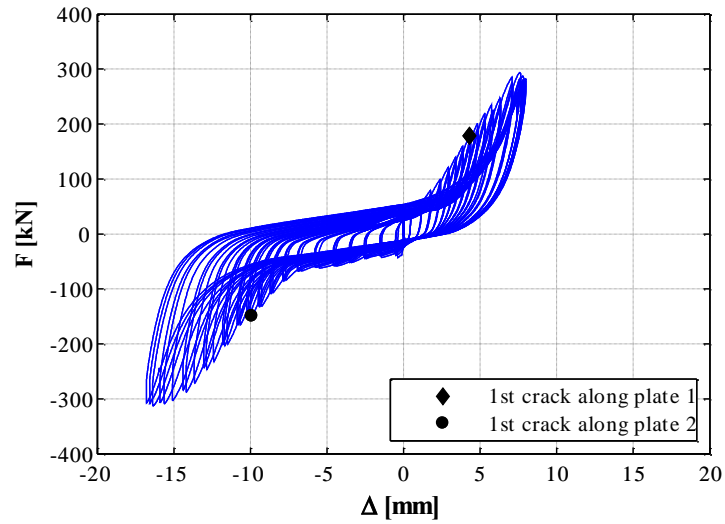

Fig. 9 Force-displacement curve for the cyclic shear test 1 on the retrofitted specimen

1
2

3 Fig. 10 shows the cracking pattern on both the sides of the beam (node 2) at the end of the test.
4 Most of the cracks were recorded at the node 2 due to the large compressive and tensile axial forces,
5 transmitted by both the two steel plates during the cyclic test. The concrete cracks propagated up to
6 the bottom of the beam (Fig. 13). Fig. 14 shows the final state of the column: few cracks, with
7 limited length and width, were recorded.



(a)



(b)

Fig. 10 Cracking pattern around the node 2 after the test 1: (a) West and (b) East side

8

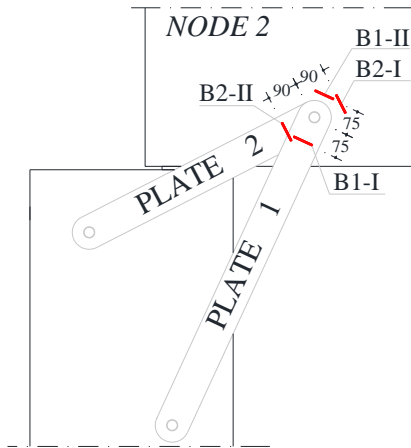

Fig. 11 Layout for strain gauges around node 2 (on the beam), along the plate 1 and plate 2

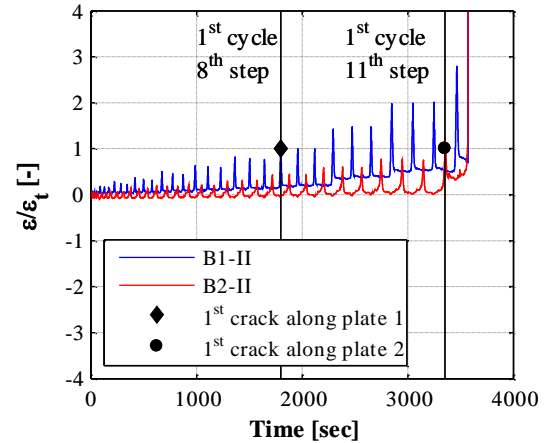

Fig. 12 Axial strain on the concrete surface around node 2 (test 1)



Fig. 13 Cracking pattern on the West side-bottom surface of the beam (test 1)



Fig. 14 Cracking pattern around the node 3 East side (test 1)

1 In order to limit the concrete cracking around the node 2, a rubber hose was installed around the
 2 horizontal dowel in the beam in the second cyclic shear test on the retrofitted connection (test 2).
 3 Fig. 15 shows the behavior of the connection during the test 2 in terms of horizontal forces and
 4 relative displacements. The specimen showed a quite symmetrical behavior up to the end of the test.
 5 Fig. 16 shows the recorded axial strain on the beam (strain gauges B1-II and B2-II in Fig. 11)
 6 during the test divided by the axial strain which corresponds to the concrete tensile strength. The
 7 first crack occurred around the node 2, as in the test 1, where larger local stresses are recorded with
 8 respect to the other two nodes, for positive shear loads in the connection. However, the presence of
 9 the rubber hose increases the connection flexibility; during the test 2, the first crack occurred at a
 10 later step of the load protocol (i.e. during the first cycle of the 10th step) at a larger beam-to-column
 11 relative displacement (8mm) and at a lower shear force in the connection, equal to 119.86kN. After
 12 the attainment of the first crack, the retrofitted connection still showed an increasing shear strength
 13 with a maximum shear force equal to 311.32kN for pushing loads (positive values). The maximum
 14 shear strength of the retrofitted connection for pulling loads (negative values) was equal to
 15 284.54kN.

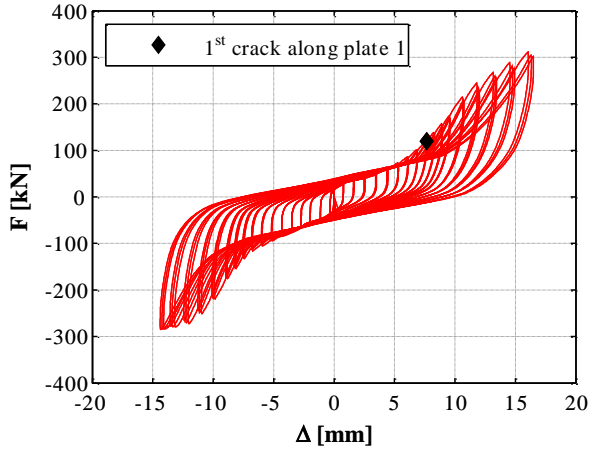

Fig. 15 Force-displacement curve of the cyclic shear test on the retrofitted connection (test 2)

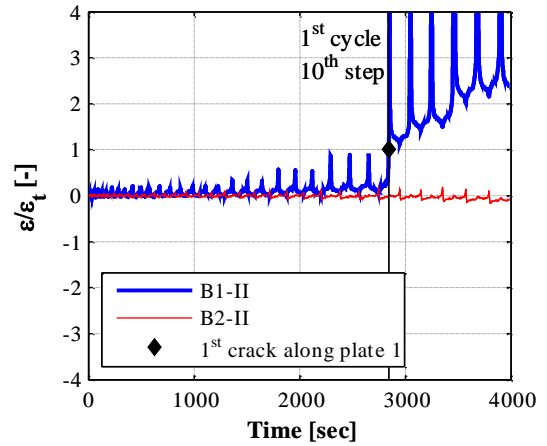

Fig. 16 Axial strain on the concrete surface around node 2 (test 2)

1 The rubber hose around the steel dowel in the beam (node 2) was significantly damaged (Fig. 17) at
 2 the end of the test and the surrounding grout crushed. Moreover, the neoprene pad showed large
 3 deformations due to the large compressive loads (Fig. 18). Several inclined cracks appeared in the
 4 concrete around the node 2 at both the sides of the specimen (Fig. 19). However, in this test the
 5 width and the length of the crack were smaller than in the test 1 because of the positive effect of the
 6 rubber.



Fig. 17 Rubber hose damage (test 2)



Fig. 18 Neoprene pad deformation (test 2)

7



(a)



(b)

Fig. 19 Cracks pattern at the node 2 at the end of the test 2: (a) West and (b) East view

8

1 4 Comparisons and discussions

2 This section aims at comparing the cyclic behavior of the two tested retrofitted connections (test 1
3 and test 2). Moreover, the performance of the retrofitting solution is compared to the performance
4 of a dowel connection, typically used for beam-to-column connections in precast structures. The
5 envelopes of the force-relative displacement curves as well as the amount of dissipated energy
6 during the cyclic response, i.e. the area enclosed by the force-relative displacement curves, describe
7 the connection capacity in terms of shear strength and ductility. The recorded strains for concrete
8 and steel members describe the performance of the retrofitting systems as well as the damage
9 pattern and the failure mechanism.

10 Fig. 20 shows the envelopes of the force-relative displacement curves of the three investigated
11 cyclic tests. For all the investigated tests, the load protocol consisted of increasing displacement
12 steps and, for each step, three complete cycles (negative and positive semi-cycles) were performed.
13 Since, at each step, the maximum value of the shear force was reached at the first cycle, the
14 envelope takes into account only the first cycle of each step. Moreover, in Fig. 20 the envelope of
15 the shear test on the dowel connection (black solid curve) is showed up to the 20% strength
16 degradation, assumed as the attainment of the connection failure (see section 2). The comparison
17 demonstrates that the retrofitted connections (blue dash-dot and red dashed curves in Fig. 20) show
18 lower initial stiffness with respect to the dowel connection (black solid curve in Fig. 20). This is due
19 to the geometrical tolerance between the steel elements in the connections and to the rubber hose
20 deformations (such as for the test 2 in the red dashed curve in Fig. 20). In particular, the initial
21 stiffness for pushing loads is equal to 508.13kN/mm for the dowel connection, equal to
22 99.54kN/mm for the retrofitted connection without rubber hose and equal to 42.92kN/mm for the
23 retrofitted connection with rubber hose. Instead, for pulling loads, the initial stiffness is equal to
24 828.94kN/mm, 113.63kN/mm and 116.5kN/mm, respectively.

25 In terms of maximum recorded shear forces, the dowel connection performed the lowest shear
26 strength in both the considered load directions. Moreover, the cyclic behavior of the dowel
27 connection is strongly not symmetric in the two loading directions; a sudden strength and stiffness
28 deterioration was recorded for pulling loads after the concrete cover failure. The first tested
29 retrofitted connection (test 1, blue dash-dot curve in Fig. 20) shows a larger shear strength with
30 respect to the dowel connection in both the directions. Moreover, the similar performance in terms
31 of maximum shear strength, for both the loading directions, demonstrates the efficiency of the
32 retrofitting system. However, it is worth to underline that this connection shows larger relative
33 displacements for pulling loads (force negative values) with respect to pushing loads, due to a
34 significant damage around the horizontal steel dowels for this load direction.

35 The retrofitted connection of test 2 (red dashed curve in Fig. 20) shows a good cyclic performance,
36 with both large shear strength values and a quite symmetric response. The rubber hose around the
37 horizontal dowel in the beam led to a lower initial stiffness (about 60%) in test 2 than in test 1 for
38 pushing loads (force positive values) because of its flexibility; on the contrary, for pulling loads the
39 initial stiffness of the two systems is quite similar, because of the significant concrete damage
40 around the beam dowel in test 1.

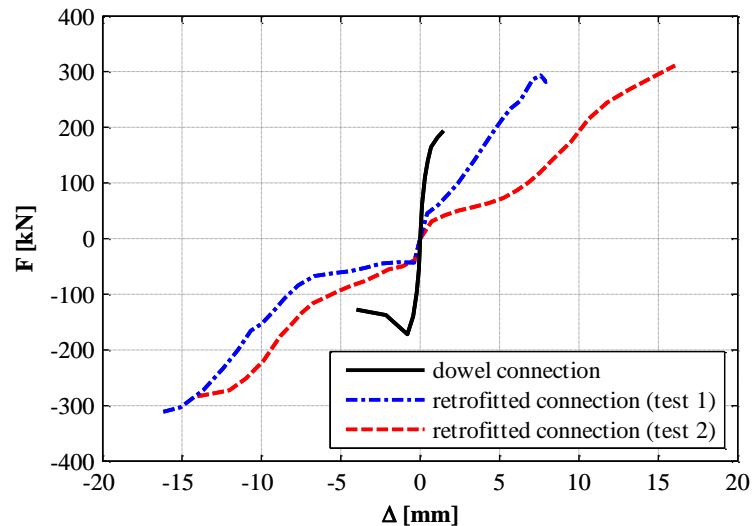

1
2
3
4

Fig. 20 Force-displacement envelopes of the tests on the dowel beam-to column connection (black solid curve) and on the two retrofitted connections, i.e. without (blue dash-dot curve) and with (red dashed curve) the rubber hose around the horizontal dowel

5 Fig. 21 shows the dissipated energy at each negative semi-cycle, corresponding to pulling loads, for the three investigated tests: the dowel connection (black bars), the retrofitted connection without the rubber hose (blue bars) and the retrofitted connection with the rubber hose (red bars). The dissipated energy of the dowel connection is plotted only for the first six steps, i.e. until the assumed failure of the connection. Up to the fourth step of the test on the dowel connection (i.e. the step which corresponds to the first crack formation), its dissipated energy was strongly lower than the dissipated energy in the retrofitted solutions because of the large initial stiffness. After the first concrete crack, the dissipated energies in the dowel connection and in the retrofitted solutions were quite similar, because of the increased deformability of the dowel connection due to the concrete damage. The dissipated energy in the two retrofitted connections increased up to the end of the shear tests; moreover, the deformation of the rubber hose around the horizontal dowel in the beam led to larger relative displacements (lower stiffness of the beam-to-column connection) and dissipation. This evidence resulted in larger values of the dissipated energy for test 2 than for the test 1.

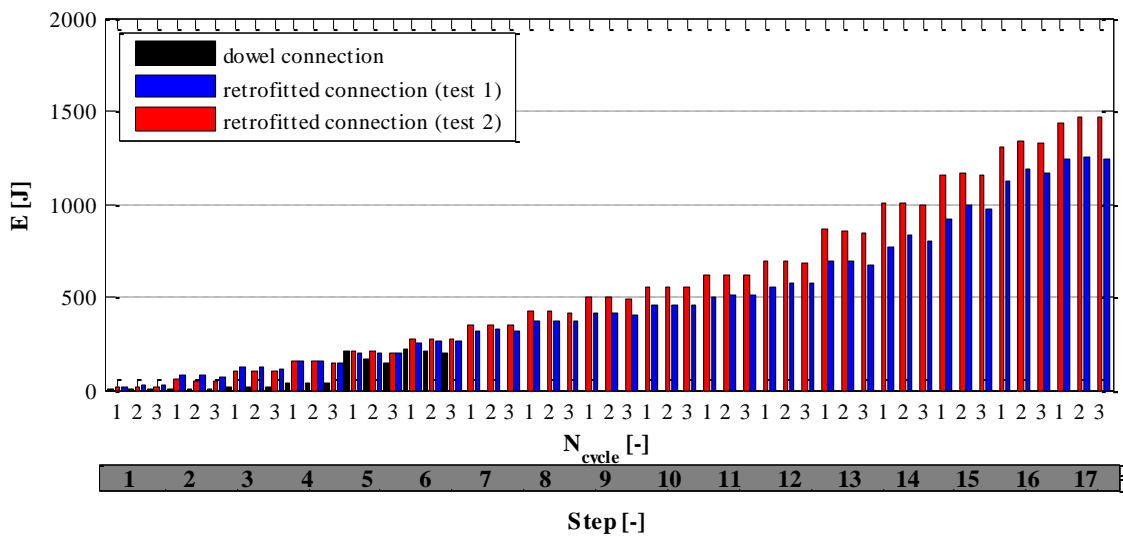

19
20
21

Fig. 21 Dissipated energy during the negative semi-cycles of the shear tests on the dowel beam-to column connection (black bars) and on the two retrofitted connections, without (blue bars) and with (red bars) the rubber hose

1 Fig. 22 shows the dissipated energy at each positive semi-cycle (i.e., pushing loads) for the three
 2 investigated connection systems. The dissipated energy of the dowel connection is much lower than
 3 the one recorded in the retrofitted solutions. Furthermore, the dissipated energy values recorded
 4 during the test 1 are significantly lower than the values recorded during the test 2.

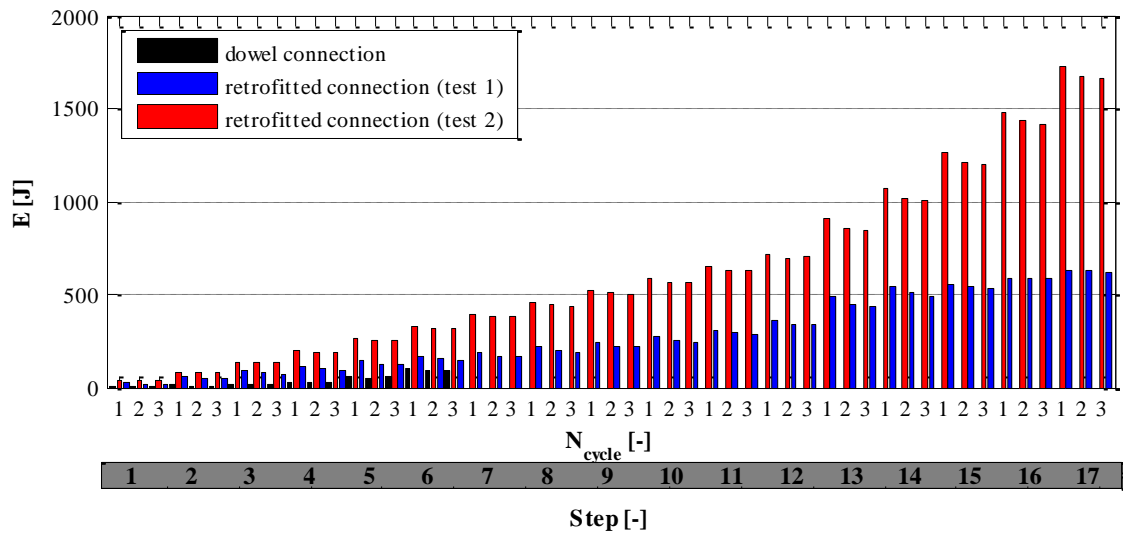

5
 6 **Fig. 22** Dissipated energy during the positive semi-cycles of the shear tests on the dowel beam-to column connection
 7 (black bars) and on the two retrofitted connections, without (blue bars) and with (red bars) the rubber hose

8 The good performance of the retrofitted connections can be also demonstrated in terms of local
 9 strains in the steel and the concrete elements.
 10 The axial steel strains, recorded along the inclined steel plates and along the horizontal steel dowels,
 11 confirm the three-hinge arch mechanism and the dowel action. Fig. 23 and Fig. 24 show the ratio
 12 between the recorded axial strains ε on the steel plates (plate 1 and plate 2) of the East side system
 13 and the yielding value $\varepsilon_{y,plate}$ corresponding to the adopted steel for both the test 1 and 2. In both the
 14 tests, the strain values of the plate 2 (red solid line in Fig. 23 and Fig. 24) were larger than those
 15 ones of the plate 1 (blue dashed line in Fig. 23 and Fig. 24) due to the geometrical configuration.
 16 However, both the steel plates did not reach the yielding limit up to the end of the tests. Moreover,
 17 the axial strain trend of the two steel plates confirms the effectiveness of three-hinged arch
 18 mechanism, since the two plates work in tension and in compression, alternatively.

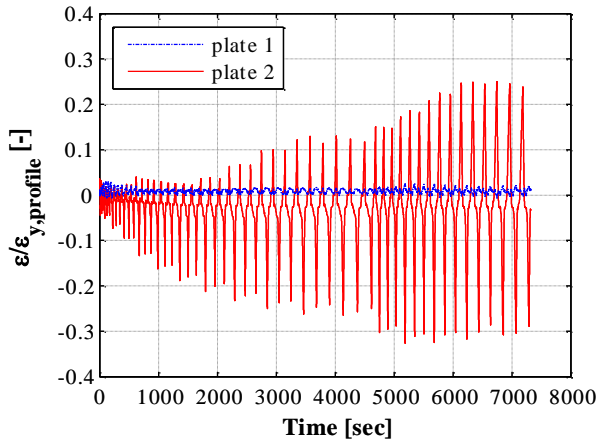

Fig. 23 Records of the strain gauges on the steel plates on the East side (test 1)

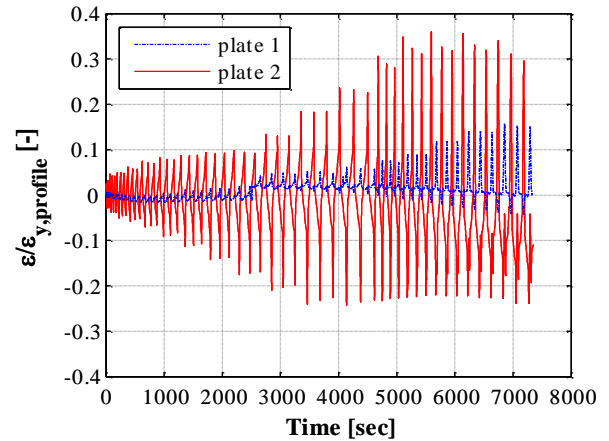

Fig. 24 Records of the strain gauges on the steel plates on the East side (test 2)

1 Fig. 25 and Fig. 26 show the ratio between the axial strains ε recorded along the steel dowels (Fig.
 2 5) in the column (in the node 1 and the node 3) and their limit yielding value, $\varepsilon_{y,dowel}$. The values
 3 recorded in the node 3 (red solid line in Fig. 25 and Fig. 26) were larger than the strains recorded in
 4 the node 1 (blue dashed line in Fig. 25 and Fig. 26). This result confirms the large forces in the plate
 5 2 during the cyclic test. In particular, during the test 1 the horizontal dowel in the node 3 reached
 6 the yielding strain for large values of the shear force in the connection (270.88kN), during the first
 7 cycle of the 13th step (4755 sec). Lower values are recorded during the test 2: this confirms that the
 8 presence of the rubber hose around the horizontal steel dowel in the beam (node 2) leads to a lower
 9 shear force in the column (node 1 and 3). The recorded axial strains in the horizontal dowel passing
 10 through the beam are not showed, because the corresponding strain gauges failed at the beginning
 11 of the test due to the concrete damage in the node 2.

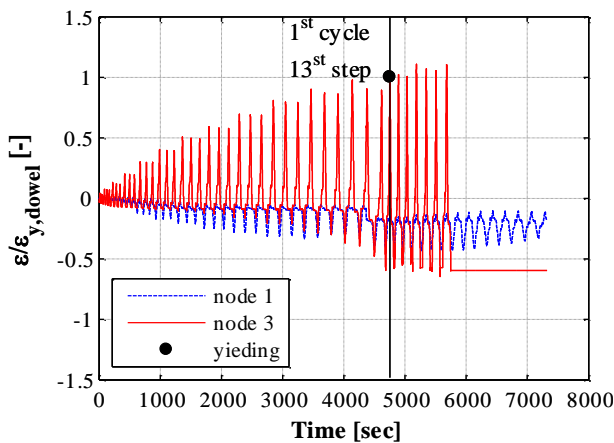

Fig. 25 Records of the strain gauges on the horizontal steel dowels in the column (test 1)

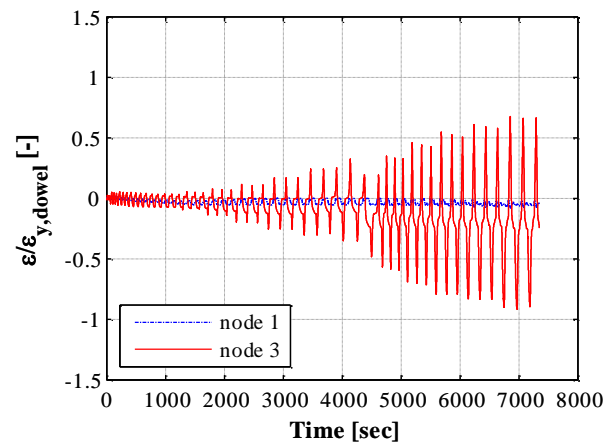
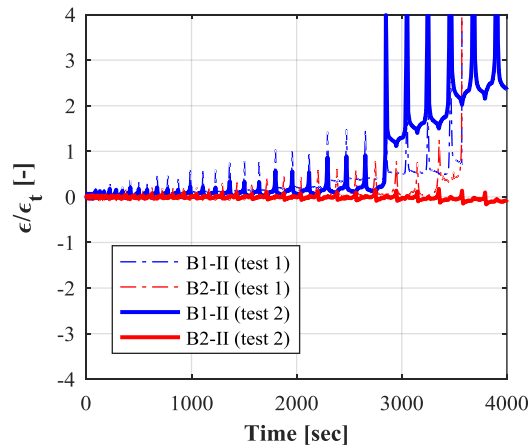

Fig. 26 Records of the strain gauges on the horizontal steel dowels (test 2)

12 The good performance of the retrofitting system also results in a less developed damage pattern for
 13 the retrofitted connection systems with respect to the dowel connection. The records of the strain
 14 gauges on the concrete beam surface (node 2 of Fig. 11) can describe the development of the
 15 damage during the test. Fig. 27 shows the ratio between the recorded strain values (ε) on the
 16 concrete surface (for the beam) and the concrete tensile strain which corresponds to the attainment
 17 of the concrete tensile strength (f_{ctm}), i.e. $\varepsilon_t=0.01\%$. The instrumentation records represented by
 18 dashed and thinner lines correspond to the test 1, whereas the solid and thicker ones correspond to

1 test 2. It can be pointed out that the presence of the rubber hose around the horizontal steel dowel
2 reduces the concrete damage in the beam.



3
4 **Fig. 27** Axial strain on the concrete surface around node 2 during test 1 and test 2

5 **5 Conclusions**

6 A retrofitting solution for RC precast beam-to-column connections is presented and the results of
7 cyclic shear tests are described in order to evaluate its performance.

8 The reference specimen is a dowel beam-to-column connection, typically adopted in one-story RC
9 precast structures. This connection was tested in a previous experimental campaign under cyclic
10 shear loads up to the failure of the lateral concrete cover in the column, which caused the failure of
11 the connection. The damaged specimen was retrofitted by a three-hinged steel connection system,
12 consisting of two inclined steel plates fixed to the concrete elements by two horizontal steel dowels
13 in the column and one in the beam.

14 Two different configurations of this system were tested, i.e. without (test 1) and with (test 2) a
15 rubber hose around the dowel in the beam. The experimental results allowed to draw the following
16 conclusions.

17 • Both the configurations of the retrofitting system showed a good performance under cyclic
18 horizontal forces. In the retrofitted connection systems, the horizontal shear force was mostly
19 sustained by the three hinged arch mechanism, ensured by the two steel plates pinned to the
20 horizontal dowels.

21 • The retrofitted connections showed larger shear strength as well as larger dissipated energy
22 values than the standard dowel connection. For loads against the column core (positive direction),
23 the maximum shear force recorded in the configuration with the rubber hose (test 2) was 50% larger
24 than the force recorded in the dowel connection. For loads against the column cover (negative
25 direction), the maximum shear force recorded in the test 2 was 60% larger than the force recorded
26 in the dowel connection.

27 • The initial stiffness of the retrofitted connections was significantly lower than the stiffness
28 of the dowel connection. For the negative direction, the stiffness recorded in the two described tests
29 was almost constant and it was about 10 times lower than the stiffness of the dowel connection. For
30 the positive direction, the stiffness recorded in test 2 was about two times lower than the stiffness
31 recorded in test 1 and about 30 times lower than the stiffness of the dowel connection.

32 • In both the tests on the retrofitting system, no significant damage was recorded in the
33 concrete. The large concrete covers of the horizontal dowels prevented brittle failures in the
34 connected elements: the concrete damage was not severe up to the end of the test. However, the
35 retrofitted connection without the rubber hose showed a larger damage around the beam dowel than
36 the system with the rubber.

1 The presented configuration avoids loss of support collapses caused by excessive relative beam-to-
2 column displacements. Moreover, it increases the connection shear strength, for horizontal loads
3 along the beam longitudinal axis, and limits the beam torsional rotations. For horizontal loads in the
4 orthogonal direction, a similar system can be coupled in the transversal direction.

5
6 **Acknowledgments** This research was partially funded by the Italian Department of Civil Protection within
7 the national project DPC-ReLUIIS 2015 WP2 and by ASSOBECON (Italian Association of Precast
8 Industries). The authors also acknowledge eng. Vittorio Capozzi for the collaboration during the tests and
9 engs. Maria Gabriella Castellano and Danilo De Fusco (FIP Industriale S.P.A.) for the interesting comments.

10 **References**

- 11 Baird, A., Palermo, A., and Pampanin, S. (2011). "Facade damage assessment of multi-storey
12 buildings in the 2011 Christchurch earthquake." *Bulletin of the New Zealand Society for*
13 *Earthquake Engineering*, 44(4), 368-376.
- 14 Belleri, A., Brunesi, E., Nascimbene, R., Pagani, M., and Riva, P. (2015a). "Seismic performance of
15 precast industrial facilities following major earthquakes in the Italian territory." *Journal of*
16 *Performance of Constructed Facilities*, 29(5).
- 17 Belleri, A., and Riva, P. (2012). "Seismic performance and retrofit of precast concrete grouted
18 sleeve connections." *PCI Journal*, 57(1), 97-109.
- 19 Belleri, A., Torquati, M., and Riva, P. (2014). "Seismic performance of ductile connections between
20 precast beams and roof elements." *Magazine of Concrete Research*, 66(11), 553-562.
- 21 Belleri, A., Torquati, M., Riva, P., and Nascimbene, R. (2015b). "Vulnerability assessment and
22 retrofit solutions of precast industrial structures." *Earthquake and Structures*, 8(3), 801-820.
- 23 Biondini, F., Dal Lago, B., and Toniolo, G. (2013). "Role of wall panel connections on the seismic
24 performance of precast structures." *Bulletin of Earthquake Engineering*, 11(4), 1061-1081.
- 25 Bournas, D. A., Negro, P., and Taucer, F. F. (2013). "Performance of industrial buildings during the
26 Emilia earthquakes in Northern Italy and recommendations for their strengthening." *Bulletin*
27 *of Earthquake Engineering*, 1-22.
- 28 Capozzi, V., Castellano, M. G., and Magliulo, G. (2014). "Struttura prefabbricata e procedimento di
29 montaggio (in italian)."
- 30 Capozzi, V., and Magliulo, G. (2012). "Struttura e procedimento di montaggio della stessa (in
31 italian)."
- 32 Casotto, C., Silva, V., Crowley, H., Nascimbene, R., and Pinho, R. (2015). "Seismic fragility of
33 Italian RC precast industrial structures." *Engineering Structures*, 94, 122-136.
- 34 CEN (1990). "Eurocode 0 - Basis of structural design - EN 1990:2002." Brussels, Belgium
- 35 CEN (2004). "Eurocode 2 - Design of concrete structures - EN 1992 " Brussels, Belgium.
- 36 CEN (2005a). "Eurocode 3 - Design of steel structures - EN 1993." Brussels, Belgium.
- 37 CEN (2005b). "Eurocode 8 - Design of structures for earthquake resistance - EN 1998-1." Brussels,
38 Belgium.
- 39 CNR 10018 (1999). "Apparecchi di appoggio per le costruzioni." Bollettino Ufficiale del CNR (in
40 Italian).
- 41 CNR 10025/98 (2000). "Istruzioni per il progetto, l'esecuzione ed il controllo delle strutture
42 prefabbricate in calcestruzzo." Bollettino Ufficiale del CNR (in Italian).
- 43 D. M. 14/01/2008 (2008). "Norme Tecniche per le Costruzioni." G.U. n. 29 4 febbraio 2008 (in
44 Italian).
- 45 da Fonseca, T. d. C. S., de Almeida, S. F., and de Hanai, J. B. (2011). "Beam-to-Column
46 Connection of a Precast Concrete Frame Strengthened by NSM CFRP Strips." *Advances in*
47 *FRP Composites in Civil Engineering*, L. Ye, P. Feng, and Q. Yue, eds., Springer Berlin
48 Heidelberg, 858-861.

- 1 Dal Lago, B., Toniolo, G., and Lamperti Tornaghi, M. (2016). "Influence of different mechanical
2 column-foundation connection devices on the seismic behaviour of precast structures."
3 *Bulletin of Earthquake Engineering*, 14(12), 3485-3508.
- 4 ETAG (1997). "Guideline for European technical approval of Metal anchors for use in concrete."
5 *EOTA*.
- 6 Faggiano, B., Iervolino, I., Magliulo, G., Manfredi, G., and Vanzi, I. (2009). "Post-event analysis of
7 industrial structures behavior during L'Aquila earthquake." *Progettazione Sismica*(English
8 Special Edition), 203-208.
- 9 Fischinger, M., Kramar, M., and Isaković, T. (2008). "Cyclic response of slender RC columns
10 typical of precast industrial buildings." *Bulletin of Earthquake Engineering*, 6(3), 519-534.
- 11 Gruppo di Lavoro Agibilità Sismica dei Capannoni Industriali (2012). "Linee di indirizzo per
12 interventi locali e globali su edifici industriali monopiano non progettati con criteri
13 antisismici (in italian)." [http://www.reluis.it/images/stories/Linee di indirizzo GDL Capannoni.pdf](http://www.reluis.it/images/stories/Linee_di_indirizzo_GDL_Capannoni.pdf).
- 14 Kramar, M., Isaković, T., and Fischinger, M. (2010). "Seismic collapse risk of precast industrial
15 buildings with strong connections." *Earthquake Engineering & Structural Dynamics*, 39(8),
16 847-868.
- 17 Kremmyda, G. D., Fahjan, Y. M., and Tsoukantas, S. G. (2014). "Nonlinear FE analysis of precast
18 RC pinned beam-to-column connections under monotonic and cyclic shear loading."
19 *Bulletin of Earthquake Engineering*, 12(4), 1615-1638.
- 20 Legge 01/08/2012 n. 122 (2012). "Conversione in legge, con modificazioni, del decreto-legge 6
21 giugno 2012, n. 74, recante interventi urgenti in favore delle popolazioni colpite dagli eventi
22 sismici che hanno interessato il territorio delle province di Bologna, Modena, Ferrara,
23 Mantova, Reggio Emilia e Rovigo, il 20 e il 29 maggio 2012 (in Italian)." *Gazzetta Ufficiale*
24 n. 180 del 03/08/2012.
- 25 Magliulo, G., Capozzi, V., Fabbrocino, G., and Manfredi, G. (2011). "Neoprene-concrete friction
26 relationships for seismic assessment of existing precast buildings." *Engineering Structures*,
27 33(2), 532-538.
- 28 Magliulo, G., Ercolino, M., Cimmino, M., Capozzi, V., and Manfredi, G. (2014a). "FEM analysis of
29 the strength of RC beam-to-column dowel connections under monotonic actions."
30 *Construction and Building Materials*, 69, 271-284.
- 31 Magliulo, G., Ercolino, M., Cimmino, M., Capozzi, V., and Manfredi, G. (2015). "Cyclic shear test
32 on a dowel beam-column connection of precast buildings." *Earthquakes and Structures*,
33 9(3), 541-562.
- 34 Magliulo, G., Ercolino, M., Petrone, C., Coppola, O., and Manfredi, G. (2014b). "Emilia
35 Earthquake: the Seismic Performance of Precast RC Buildings." *Earthquake Spectra*, 30(2),
36 891-912.
- 37 Magliulo, G., Fabbrocino, G., and Manfredi, G. (2008). "Seismic assessment of existing precast
38 industrial buildings using static and dynamic nonlinear analyses." *Engineering Structures*,
39 30(9), 2580-2588.
- 40 Ozden, S., Akpınar, E., Erdogan, H., and Atalay, H. M. (2014). "Performance of precast concrete
41 structures in October 2011 Van earthquake, Turkey." *Magazine of Concrete Research*,
42 66(11), 543-552.
- 43 Psycharis, I. N., and Mouzakis, H. P. (2012). "Shear resistance of pinned connections of precast
44 members to monotonic and cyclic loading." *Engineering Structures*, 41, 413-427.
- 45 Toniolo, G. (2012). "SAFECAST project: European research on seismic behaviour of the
46 connections of precast structures." *15th World conference on earthquake engineering*
47 *(15WCEE), Lisbon, Portugal*.
- 48 Toniolo, G., and Colombo, A. (2012). "Precast concrete structures: The lessons learned from the
49 L'Aquila earthquake." *Structural Concrete*, 13(2), 73-83.
- 50

1 Vintzeleou, E. N., and Tassios, T. P. (1986). "Mathematical-Models for Dowel Action under
2 Monotonic and Cyclic Conditions." *Magazine of Concrete Research*, 38(134), 13-22.

3 Zoubek, B., Fischinger, M., and Isakovic, T. (2015). "Estimation of the cyclic capacity of beam-to-
4 column dowel connections in precast industrial buildings." *Bulletin of Earthquake*
5 *Engineering*, 13(7), 2145-2168.

6 Zoubek, B., Isakovic, T., Fahjan, Y., and Fischinger, M. (2013). "Cyclic failure analysis of the
7 beam-to-column dowel connections in precast industrial buildings." *Engineering Structures*,
8 52(0), 179-191.

9